



# ELEKTRA FloorTec

## Product Guide & Instructions

### About Elektra FloorTec

Elektra FloorTec is designed for use on WoodTec heating mats to receive a carpet and/or vinyl floor covering (including Amtico and Karndean)  
 No specialist tools are required for the installation of Elektra FloorTec and easy removal is possible when required.  
 A packet of MDF panels covers 3.6m<sup>2</sup> and contains 5 panels 3mm thick (coloured adhesive) and 5 panels 4mm thick (clear adhesive), each panel measures 1.2m x 0.6m. Shelf life is 12 months (unopened) avoid high temperatures and frost.

### Installation Advice

#### Installing the Vapour Barrier, Izotherm & WoodTec heating mat

Start off by laying the vapour barrier, lay the vapour barrier to cover the whole floor area (only lay the vapour barrier on the bottom if your floor base is concrete). Once the vapour barrier has been laid out, unpack the Izotherm insulation sheets and cover the whole floor area, lay the Izotherm insulation boards brickwork fashion (Fig. 6). Once the vapour barrier and Izotherm are down, lay out the WoodTec heating mat(s), refer to the WoodTec instruction manual on how to install the mats. Once the WoodTec mat is down, lay another layer of vapour barrier to cover the whole area (Fig. 1). You are now ready to install the FloorTec system;



Fig. 1

#### Installing the FloorTec System

Allow Elektra FloorTec to acclimatise in the room in which it is to be laid for 24 hrs before installation. When covering large floor areas, the maximum run of Elektra FloorTec panels in any direction is 10metres. With rooms extending more than 10 metres in either direction an expansion gap must be incorporated every 10 metres. This gap should be treated as a movement joint and should not be bridged by the floor covering. If necessary the expansion gap should be bridged using a suitable expansion joint cover. Elektra FloorTec can be cut from the top using a straight cutting blade, and then snapped (Fig. 2). Maintain a gap of at least 6 mm between panels and walls. Start at the shorter wall of the room with a row of 3 mm panels cut in half lengthways (coloured adhesive uppermost)(Fig. 3). Place a row of full-size 3 mm panels (coloured adhesive uppermost) staggered against the first row of the cut the panels – ideally in a brickwork fashion (Fig. 6). Place a row of full-size 4 mm panels (clear adhesive downwards) overlapping the second row of the 3 mm panels halfway (Fig. 4) Install the remaining panels, covering the whole area in this manner (Fig. 5).

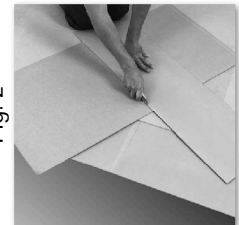

Fig. 2

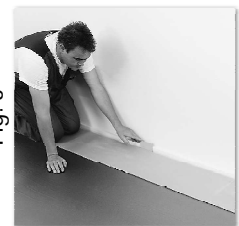

Fig. 3

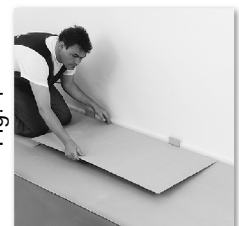

Fig. 4



Fig. 5

#### Notes

Carpet can be laid directly on top of FloorTec, you can use underlay if needed, however, the total combined Tog rating should not be greater than 2.5 Tog as high Tog rated carpets can stop the heat coming through. To fix carpet onto FloorTec we recommend you using the double stick method or using a tackifier adhesive, If installing using the stretch method the gripper must be installed before the heating system, in order for the gripper to function properly the top surface of the gripper should be level with the top surface of the FloorTec or underlay.

When installing the FloorTec System, the WoodTec mat must be turned off, if the floor finish is going to be glued to the FloorTec System the WoodTec mat must not be turned on until the glue has completely set, the floor temperature should then be gradually increased.

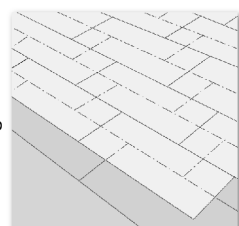
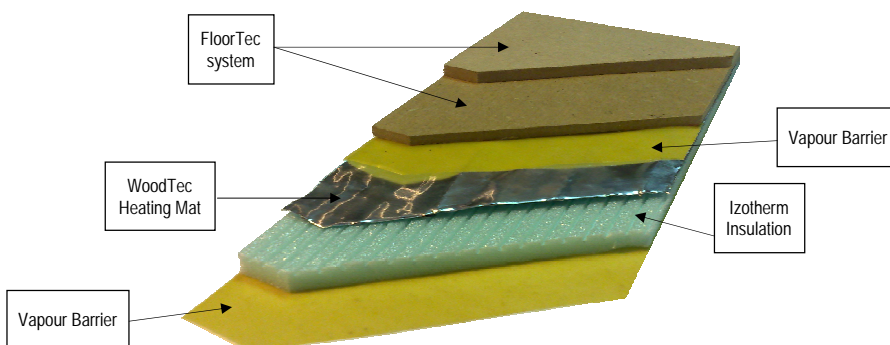

Fig. 6

**ELEKTRA**

# **WoodTec™**

**HEATING MATS**



Designed to be installed  
under laminate flooring and/or  
engineered wood

---

Installation manual  UK 

Instrukcja montażu  PL

Инструкция по монтажу  RU



## Purpose

The *ELEKTRA WoodTec*<sup>™</sup> heating mats are designed to provide heating of floors made of laminated floorboards and/or engineered wood. They can be used as a supplementary heating system to achieve the “warm floor effect”. In very well insulated buildings they may be installed as the primary heating system.

## Specification

The *ELEKTRA WoodTec*<sup>™</sup> heating mats are produced as pre-assembled installation sets with dimensions of 50 cm (width) x 4.0 to 26.0 m (length). There are heating cables attached to a fiberglass mesh and covered with aluminum foil on the reverse side. The aluminum foil provides a protective shielding for the heating cables. It is possible to install multiple mats in one room. In such a case, the mats should be electrically connected in parallel.

The *ELEKTRA WoodTec<sub>1</sub>*<sup>™</sup> heating mats are **1.5mm** thick and have 4.0m cold tails at both ends.

The *ELEKTRA WoodTec<sub>2</sub>*<sup>™</sup> heating mats are **2.8mm** thick and have a 4.0m cold tail at one end, and a joint at the other.

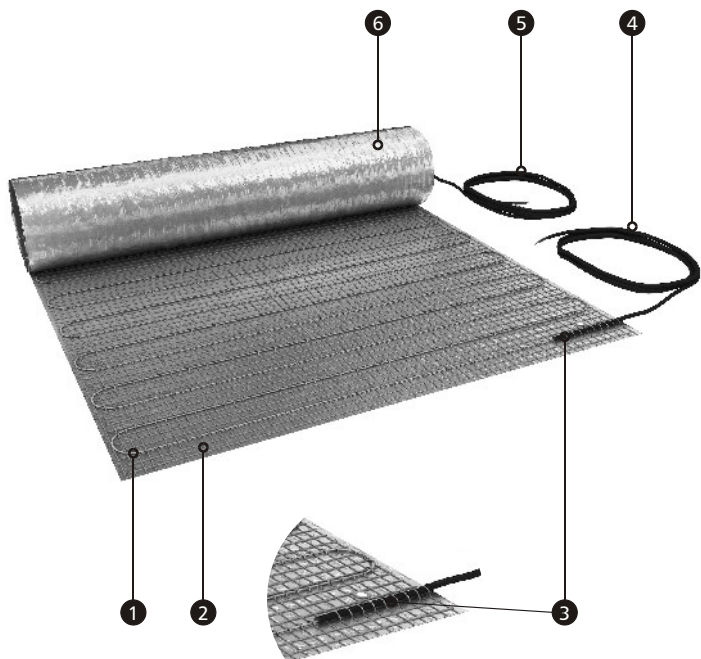

**ELEKTRA WoodTec1™ heating mat**

- ① Heating cable
- ② Fiberglass mesh
- ③ Heating cable joint to cold tail
- ④ Shielded (PE) cold tail (L – black or brown)
- ⑤ Shielded (PE) cold tail (N - blue)
- ⑥ Aluminum shield

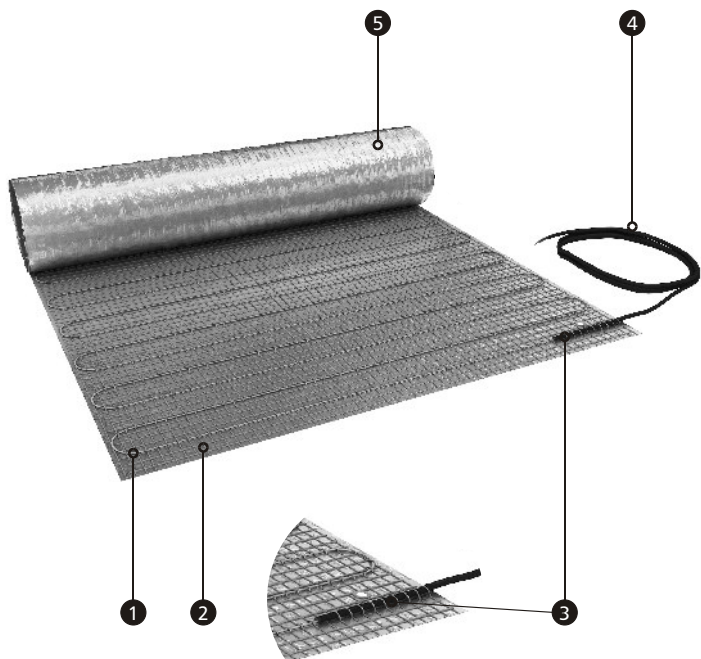

***ELEKTRA WoodTec2™*** heating mat

- ① Heating cable
- ② Fiberglass mesh
- ③ Heating cable joint to cold tail
- ④ Shielded (PE) twin-conductor cold tail  
(L – black or brown, N – blue)
- ⑤ Aluminum shield

**Note:**

The power output of the heating mats can vary +5%, -10% from the provided nominal specifications.

The heating mats suitable for use with a 230V/50Hz power supply.

Following symbols are used on rating labels of the **ELEKTRA WoodTec™** heating mats:



Double-sided  
power supply  
(**ELEKTRA WoodTec<sub>1</sub>™**)



Single-sided  
power supply  
(**ELEKTRA WoodTec<sub>2</sub>™**)



Heating mat with  
foil facing up



Direct in-floor  
heating

## Materials and tools

required for installation

- The ELEKTRA *WoodTec*™ – included with heating mat
- Flexible Conduits – included with 1.5 and 2.5 m in length heating mat
- Deep installation box – included with heating mat
- 2 electrical connectors – included with (*ELEKTRA WoodTec1*™ only) heating mat
- Strips of aluminum self-adhesive tape with conductive adhesive – included with heating mat
- Temperature controller – included with heating mat *option*
- Scissors/cutters
- Ohmmeter (multimeter)
- Tools for cutting chases in walls and floors

### Caution:



**Never** cut heating cables. Only the plastic mesh and aluminum foil may be cut.

**Never** shorten the mats. Only cold tails may be made shorter, if necessary.

**Never** attempt to repair the heating cables. If damage occurs to the heating cables, contact an ELEKTRA-authorized installer.



**Caution:**

**Never** apply excessive tension to the heating mat. Do not hammer the mat with sharp tools.

**Never** install the heating mat if the ambient temperature drops below -5°C.

**Never** install the mats in places where fixed furniture items are planned to be placed (such as wardrobes without feet).

**Never** use installation materials other than those specified in the installation manual.

**Never** use nails or screws for installation.

**Caution:**

**Always** install the heating mat according to the installation manual.

Electrical connection of the mat **must be** performed by a certified electrician.

The heating mat **should be** placed at least 50mm away from other heat sources (e.g. hot water pipes).

## Choosing the right heating mat

Before choosing the heating mat(s) for a room (the heating mats come with a fixed width of 50 cm), plan their arrangement on the floor or on the selected floor areas. The heating mats must not be laid in places where fixed pieces of furniture will later stand. The heating mats can be cut to a desired shape and then laid out in various directions. While cutting the mat, cut the fiberglass mesh and aluminum foil but never the heating cables.

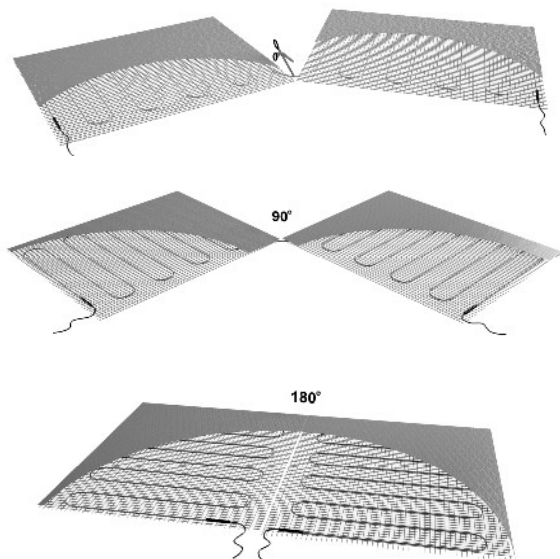

Laying out a custom-shaped heating mat

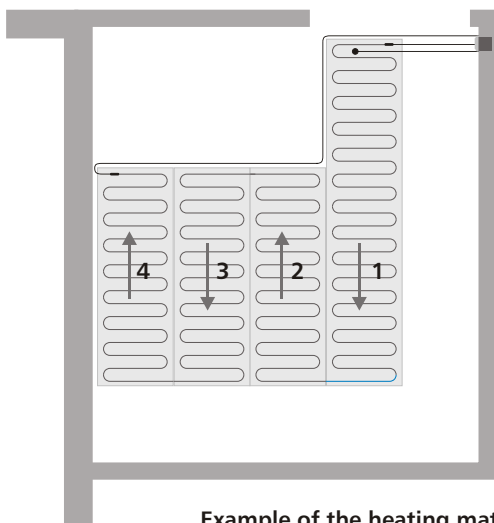

## Choosing the temperature controller

A temperature controller is a core component of any floor heating. The controller connects the mat with the electrical system and ensures that the required temperature of the floor or ambient air in the room is maintained.

- If the heating mats serve as a supplementary heating source in the room and the user desires merely to enjoy a warm floor feeling, then a controller equipped with a floor temperature sensor is sufficient to keep the required temperature of the floor.
- If the heating mats are the primary heating source in the room, then what the user usually wants is the optimum ambient temperature. In such a case, a temperature controller that can measure air temperature should be installed. Such a temperature controller should be equipped with both an air temperature sensor and an additional floor temperature sensor (while measuring the ambient temperature, it protects the floor and the heating mat from overheating).

For temperature control, either a manual electronic controller may be used which keeps constant temperature or a programmable electronic controller which can be programmed in a daily and/or a weekly cycle.

Heating type	Temperature controller type	
	Electronic manual	Electronic programmable
Supplementary for the "warm floor effect"	ELEKTRA OTN 1991 OTN2 1991 OTD2 1999	ELEKTRA OCC2 1991 OCD2 1999 DIGI2p
Primary	ELEKTRA OTD2 1999	ELEKTRA OCD2 1999



**Temperature sensor**

**Temperature controller** may be installed under a common faceplate with a lighting switch (not applicable in the UK).

## Step 1 – preparation

As preparation for the installation take the following steps:

1. Choose a location for the temperature controller. For aesthetic and practical reasons, it is best to install the controller next to the lighting switches (e.g. under a common faceplate).
2. Install a deep installation box for the temperature controller.
3. Install a suitable 3-wire power supply to the thermostat position / installation box. Connect the power cable.
4. Install 2 flexible conduits (Ø 15mm) between the installation box and the floor. The flexible conduits should be laid in the previously made chases in the wall and in the floor. Depth of the groove should be 10-12mm. Later, when the heating mat is installed, the temperature sensor cable will be fed into one of the flexible conduits and the cold tails to the other.

**The flexible conduits must not be sharply angled at the meeting point of the wall and the floor. Make sure that a smooth curve is provided.**

- ① Deep installation box for the temperature controller
- ② Flexible Conduit for the floor temperature sensor
- ③ Flexible Conduit for the power leading to the heating mat

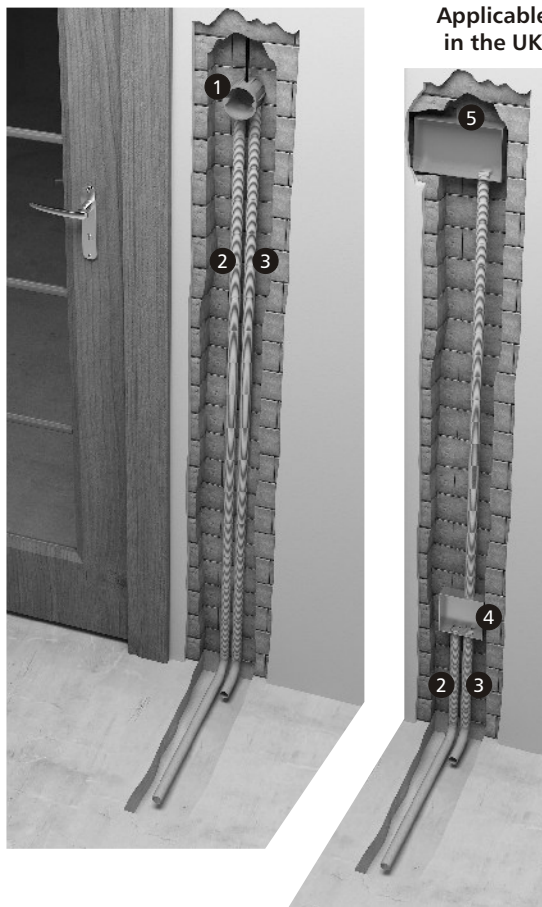

- ④ Single Installation Box for multiple mat connections (if required).
- ⑤ Dual Installation Box for thermostat and fused connection unit (spur).

## Step 2 – laying the heating mat

A floor prepared for laminate flooring and/or engineered wood should be even, smooth, dry, and stable (max. permissible level deviations are 2 mm/sq. m).

1. Lay the Vapour Barrier over the prepared floor surface. The Vapour Barrier thickness should be at least 0.2 mm. Provide at least 20 mm wide overlaps between vapour barrier sheets. Turn up the edges of the **vapour barrier sheets against the walls up to 5 cm.**

Before laying the insulating underlay and heating mat, feed the temperature sensor wire into the installed flexible conduit. Place the temperature sensor under the heated surface. Later, to ensure that the floor is even and level and the temperature readings by the sensor are correct. You will have to cut out a section of the insulating underlay and the fiberglass mesh of the heating mat, located above the flexible conduit in the floor. The closer to the Laminate flooring and/or engineered wood the temperature sensor is placed, the more accurate reading it will obtain. Also, feed the temperature sensor cable into the installation box.





### Temperature sensor installation

- ① Laminate flooring and/or engineered wood
- ② Protective layer (PE sheet)
- ③ The **ELEKTRA WoodTec™** heating mat
- ④ Flexible conduit
- ⑤ Floor sensor
- ⑥ Insulating underlay
- ⑦ Vapour Barrier (PE sheet)

2. Place insulating underlay of at least 6 mm thick-ness over the vapour barrier.  
When choosing material for the insulating underlay, take its heat dissipation properties into consideration. The better the heat dissipation, the shorter the time to warm up the laminate flooring and/or engineered wood. Extruded polystyrene (XPS) insulating underlay meets these requirements optimally.

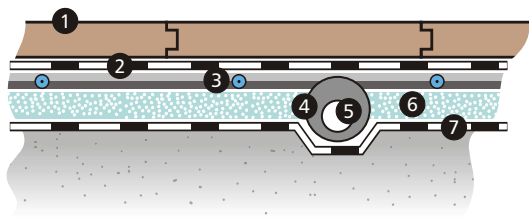

- ① Laminate flooring and/or engineered wood
- ② Protective layer (PE sheet)
- ③ The *ELEKTRA WoodTec™* heating mat
- ④ Flexible conduit
- ⑤ Floor sensor
- ⑥ Insulating underlay
- ⑦ Vapour Barrier (PE sheet)

3. It is now time to lay out the heating mat. **Always lay out the heating mat with its aluminum foil layer facing up.**

With the heating mat in place, cut grooves in the insulating underlay and in the floor if necessary to compensate for the extra thickness of the heating mat's cold tails so as to obtain level surface. Lead the cold tails of the heating mat alongside the wall and into the installation box where the temperature controller will be housed. If the cold tails are too short, they can be extended. Feed the cold tails into the flexible conduits and into the installation box. Where the cold tails meet the heating cable, cut a groove in the floor to compensate for an added thickness of the connector. If the cold lead are too short they can be extended. A "draw wire" can be used to feed cables into the flexible conduit.

If the aluminum foil was cut when the heating mat was customized, use min. 2 strips of self-adhesive aluminum tape with the conductive adhesive to join the heating mat sheets as shown in the picture. The aluminum foil serves as shielding for the heating cables, therefore the sheets must be electrically connected.

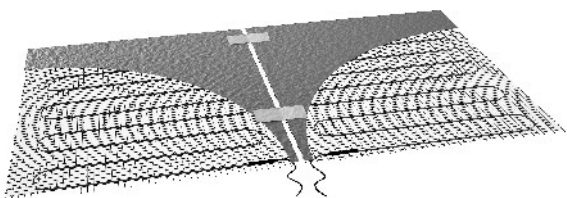

#### Joining the cut aluminum foil sheets

4. With the heating mat in place a protective layer (polyethylene foil, 0.2mm) has to be laid out on top.
5. With the heating mat installed measure:
  - the heating wire resistance
  - shielding (aluminum foil) continuity (if the aluminum foil has been cut during the heating mat layout).

These measurements will have to be completed in the Warranty Card and repeated after the floorboards have been installed and their results compared.

# Measurements

- ① Cold Tail
- ② Cold Tail
- ③ Ohmmeter (multimeter)
- ④ Aluminum shield

## ELEKTRA WoodTec<sup>1</sup>™ measurements

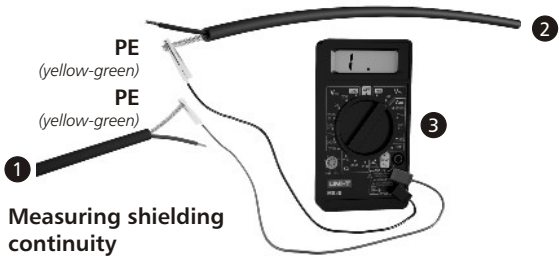
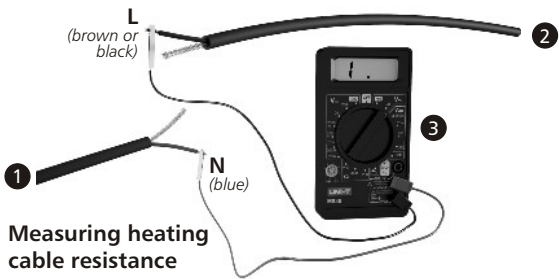

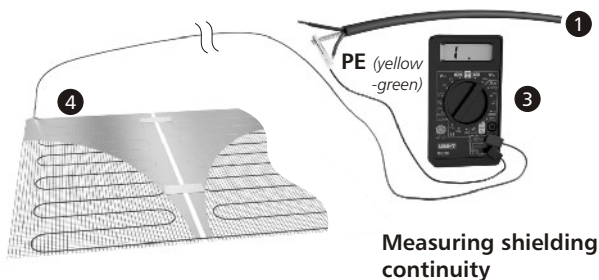
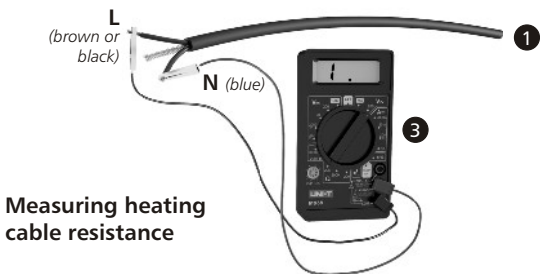
**ELEKTRA WoodTec2™ measurements**

The shielding continuity measurement has to be done by means of an ohmmeter (multimeter). The resistance between the PE wire of the cold tail and the end of the aluminum foil has to be measured.

## **STEP 3 – laying laminate flooring and/or engineered wood**

After the heating mat is laid, the temperature sensor installed, and the cold tails and the temperature sensor cords fed into the installation box, you can lay the laminate flooring and/or engineered wood.

## **STEP 4 – installing the temperature controller**

Before you can connect the heating mat(s) to the household wiring, through the temperature controller. Perform again the resistance measurements of the heating cable and insulation and of shielding continuity in order to make sure that the heating mat has not been damaged during the installation of the laminate flooring and/or engineered wood. Note the measurements on the Warranty Card.

Connection of the heating mat with the household wiring should be made by a certified electrician.

Follow the temperature controller's manual when connecting the household wiring, the cold tails of the heating mat, and the temperature sensor wire to the temperature controller inside the installation box.

**Caution:**

The heating mat's earth cables (PE) should be connected to the earth (yellow and green) of the household wiring with a special terminal  $\perp\perp$  on the temperature controller. If there is no such terminal on the temperature controller's housing, the connection should be made separately using a wire connector which will be placed in the installation box.

If several heating mats were installed in the room, connect them in parallel, i.e. cables with the same markings should lead to the same terminals on the temperature controller.

## Shock protection

The electrical system, to which the heating mat is connected should be equipped with a residual current device (RCD) rated at 30mA.

## Operation

The floor temperature of the heating system is limited by setting the desired temperature in the controller.

Note that the entire floor or a large part of it serves as a heater. Hence, heat dissipation from the floor should always remain unhindered by furniture or by the way the room is used. For that reason, do not place large footprint objects on the heated sections of the floor, such as mattress or furniture pieces without feet which have large contact surface with the floor.

Holes can be drilled in the floor only after the exact arrangement of the heating cables has been determined (based on the as-built documentation or measurements taken with a special detector).

## Warranty

**ELEKTRA provides a 10-year Warranty (from the purchase date) for the *ELEKTRA WoodTec™* heating mats.**

### Warranty conditions

1. For the warranty to apply, the following is required:
  - a) the heating system was installed in compliance with this manual
  - b) connection of the heating mat and temperature controller to the electrical system of the house as well as resistance measurements of the heating cable and shielding continuity were performed by a certified electrician



- c) Warranty Card with required entries is included
  - d) Proof of purchase for the heating mat is included
  - e) electrical system supplying power to the heating mat is equipped with a circuit breaker
2. The Warranty is void if persons other than an ELEKTRA-certified installer attempted to repair the product
  3. The Warranty does not cover:
    - a) mechanical damage
    - b) damage due to unsuitable power supply
    - c) damage resulting from electrical connection performed in violation of the regulations in force
  4. As part of the Warranty service, ELEKTRA undertakes to reimburse all costs incurred solely in connection with repairing a defective heating mat.

**Note:**

Warranty claims with included Warranty Card and the retail sales receipt must be filed with the dealer or with the ELEKTRA Company.

# Warranty Card

Customer shall keep this Warranty Card throughout the entire warranty period of 10 years. The warranty period starts from the date of product purchase.

**ELEKTRA**  
**WoodTec™**

## INSTALLATION SITE

Address	
Post Code	City

Warranty claims with included Warranty Card and the retail sale receipt must be filed with the dealer.

## TO BE FILLED BY INSTALLER

Name, Surname	Electrician's Certificate #
Address	e-mail
Zip Code	City
	phone #
	fax #

**Note:** Installer has to provide as-built documentation to the user.



**ELEKTRA WoodTec™** heating mat layout diagram



**Note:** The layout diagram must include distances between the heating mat and walls and fixed furniture with a clearly marked position of the temperature sensor and of heating cables.



Measurements	
heating core's resistance after heating mat installation	
heating core's resistance after floor installation	
shielding continuity after heating mat installation	YES <input type="checkbox"/> NO <input type="checkbox"/>
shielding continuity after floor installation (applies to <i>ELEKTRA WoodTec1</i> ™ only)	YES <input type="checkbox"/> NO <input type="checkbox"/>

Date	
Installer's signature	
Company stamp	

**NOTE!**

**Place the self-adhesive rating plate  
attached to the product here  
(must be carried out prior to installing  
the heating system)**