

USER MANUAL

Type OCD2-1999

English

Introduction

The OCD2-1999 thermostat is capable of switching on your heating system at pre determined times on different days of the week. It is possible to set 4 periods called events each day with different temperatures. From factory a default schedule is programmed suitable for most installations. Unless you change these settings the thermostat will operate to this default program.

Working with lower temperatures during times that the room is unoccupied will lower your energy costs without reducing the comfort. The thermostat has an adaptive function that automatically changes the start time of a heating period so that the desired temperature is reached at the time that you set. After 3 days the adaptive function has learned when the heating must be switched on.

The thermostat type OCD2-1999 has an external temperature sensor that is normally placed in the floor construction. In this configuration the thermostat controls the temperature of the floor and not the temperature within the room.

The thermostat has a pin button marked R, allowing you to reset the thermostat to factory settings. These are listed at the end of this manual with space for you to record your own weekly schedule.

The heating system can be switched off on the built-in interrupter. The Microprocessor taking care of the time will still be supplied with power whereby time and day will be maintained. When the heating is required and the thermostat is switched on, it will continue the 4-event programme based on present time and day.

1. Getting started

Buttons

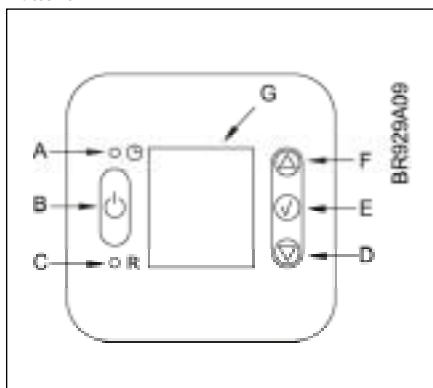

A:	B:	C:	D:
Pin button adjust of clock	On/off	Reset to factory setting	Adjustment down

E:	F:	G:
OK - accept	Adjustment up	Display

Display symbols

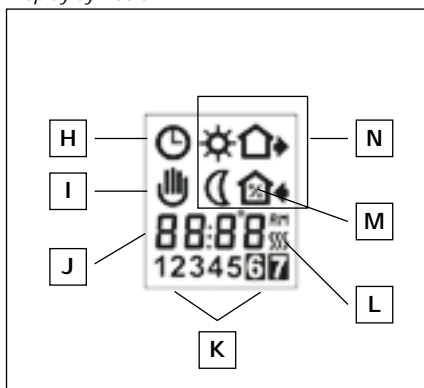

H:	I:	J:	K:
Clock function	Manual mode	Time and temperature	Day number

L:	M:	N:
Heating on	% Monitoring of switch-on time	4-event symbol Wake Out Night Home

Setting the thermostat into operation

First time power is connected the clock and day will be flashing and must be set. If you need to adjust the time of the thermostat at a later date, insert a pin into the hole for setting of time and day. Adjustment must be made for summer and winter time.

		Press the UP () or DOWN () buttons to select the correct time and press OK button () .	
		Then press the UP () or DOWN () button to select the correct day and press OK () button.	1-7

2. Daily use of the thermostat

4-event clock mode

The day has been split into 4 events describing a typical day. When the thermostat is in 4-event mode it will automatically adjust the temperature according to the required temperature to the required time. As standard the thermostat has 5 days with 4 events, and 2 days with 2 events. Programming see 3.



4-event clock mode:		The clock function symbol (⌚) and one of the 4-event symbols (☀ ☔ ☾ ☷) will be indicated. Programming see 3.
Comfort mode: 		Temporary override To temporarily override the temperature in the 4-event schedule program, press the UP (⬆) or DOWN (⬇) button once, to show the temperature, and press again to increase or decrease the temperature. The display will flash for 5 seconds, and will then revert to the time. The override will operate until the next programmed event when the unit will resume the automatic programme.
		Cancel comfort mode To cancel the override state, press the OK (✓) button twice.
Manual mode: 		Permanent override: During holidays, the scheduled 4-event program can be overridden. Press the OK (✓) button, and then the UP (⬆) or DOWN (⬇) button until the override temperature is set. The unit will now operate to this temperature permanently.
		Cancel manual mode To cancel the permanent override state press the OK (✓) button once, and the unit will resume automatic function.

3. Programming

4-event time and temperature

For each event, the start time and required temperature must be set.

For example, in the morning you wish the heating to start at 07:00 and the temperature to rise to 25°C. Press OK (✓) button for 3 seconds and the start time is displayed. Change this to 07:00 with the UP (⬆) or DOWN (⬇) button. Press OK (✓) to confirm.

The temperature is now displayed. Change this to 25°C with the UP (⬆) or DOWN (⬇) button. Press OK (✓) button to confirm. This action can now be repeated for the second event.

These settings will be valid with days 1-5 showing on the display. To program the days 6 and 7, repeat the above. Days 6 and 7 are usually Saturday and Sunday, and only have two events.

The temperature can be set within the range of +5 to +40°C. It is also possible to select the heating OFF at that event by reducing the setting to 5°C, and then pressing the (⬇) once more.

Press OK (✓) button for 3 secs. to begin programming			
Day 1 - 5			
	== ⬆ ⬇ ⬆		☀ : Time and temperature
	== ⬆ ⬇ ⬆		☔ : Time and temperature
	== ⬆ ⬇ ⬆		☾ : Time and temperature
	== ⬆ ⬇ ⬆		☷ : Time and temperature
Day 6 - 7			
	== ⬆ ⬇ ⬆		☀ : Time and temperature
	== ⬆ ⬇ ⬆		☷ : Time and temperature







4. Advanced settings and read-out

	<p>Press both UP (▲) and DOWN (▼) buttons together for 3 seconds. INFO is displayed. Press UP (▲) button until you reach the desired sub menu. Select the sub menu with the OK (✓) button.</p>
	<p>Monitoring of energy consumption The thermostat calculates average time it has been switched on allowing you to monitor your energy consumption. In the thermostat you can read out: Total switch-on time in percentage in the latest 2 days, 30 days or 365 days. Calculation of operational costs per day: (switch-on time:100) x kW x kWh-price x 24 h per day Example: Read-out: 30 % in the latest 365 days Size of heating system: 1,2 kW (ask the installer) Cost of power: 0,2 EUR / kWh Calculation: (30:100) x 1,2 kW x 0,2 EUR / kWh x 24 h = 1,7 EUR per day</p>
	<p>2 days 30 days 365 days Software version Actual sensor temperature</p> <p>Press UP (▲) or DOWN (▼) button to show the different readouts. No changes can be made here. Use the OK (✓) button to end.</p>
	<p>4-event sequence The present event sequence flashes: Days 1-5, followed by days 6-7. To change, press the UP (▲) button until you have days 1-6 and then day 7 flashing, or all 7 days are flashing. Select the required sequence with the OK (✓) button.</p> <p>5-2: 4 events in 5 days + 2 events in 2 days. 6-1: 4 events in 6 days + 2 events in 1 day 7-0: 4 events in 7 days</p>
	<p>Max and min allowed temperature range The temperature setting range of +5° to 40° C can be limited to prevent a too high or too low temperature being selected. For example, a wood floor covering should not be allowed to exceed a maximum of 27°C. Low limitation is used where the temperature of the floor is required never to fall below the minimum set temperature.</p> <p>Maximum allowed temperature setting. Use the UP (▲) or DOWN (▼) button to increase or reduce, and OK (✓) button to accept. Next is displayed LoLi. Press OK (✓) button to continue. Minimum allowed temperature setting. Use the UP (▲) or DOWN (▼) button to increase or reduce and OK (✓) button to accept.</p>
	<p>Time and temperature scale selection</p> <p>You can select either °C or °F scale, and 12 or 24 hour clock as follows: Press UP (▲) or DOWN (▼) button to change settings. Confirm the required scale with the OK button (✓) button.</p>
	<p>Adaptive function: This function enables the thermostat to calculate when it needs to switch ON so that the required temperature is reached at the set time. With a start time of 07:00 therefore, the thermostat may switch ON as early as 06:00 so that the desired temperature of 25°C is achieved by 07:00. Without this function set, the thermostat will start to heat at the time you set.</p> <p>Press the DOWN (▼) button to switch between on and off. Press OK (✓) button to confirm.</p>
	<p>Press OK (✓) button to end programming and to return to scheduled programme.</p>

5. Reset to factory setting

	Press the pin button for 3 secs. and the thermostat returns to factory settings. Time and day is also reset and must be set according to "Setting the thermostat into operation".
---	---

Factory settings

4-event time and temperature				
Day 1-5	Time		Temperature	
	06:00		25°C	
	08:00		20°C	
	16:00		27°C	
	22:30		20°C	
Day 6-7				
	08:00		27°C	
	23:00		20°C	
4-event sequence	5:2			
Hi-Low temp.	55°C / 5°C			
Scale	24 H / °C			
Adaptive control	ON			

6. Failure codes

- E0 = Internal failure, replace thermostat
- E1 = Built-in sensor short-circuit or disconnected, replace thermostat
- E2 = External sensor short-circuit or disconnected

ELEKTRA

ul. Marynarska 14
 02-674 Warszawa
 Tel. (+48 22) 843-32-82
 e-mail: info@elektra.pl
 www.elektra.pl

SERWIS

ul. Świętojerska 12
 00-236 Warszawa
 Tel./fax (+48 22) 831-20-35